

Unit 1



Unit 1



Unit 1

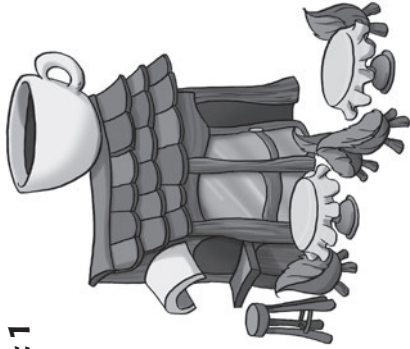

Unit 1

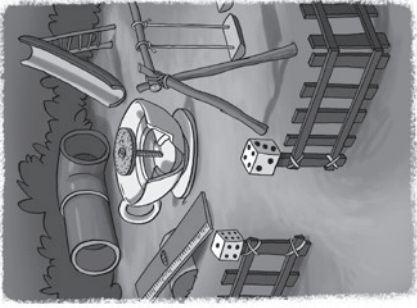

Unit 1

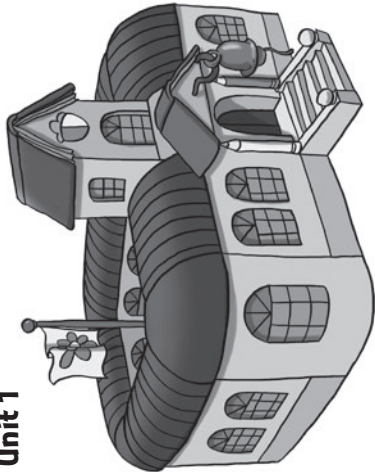

Unit 1

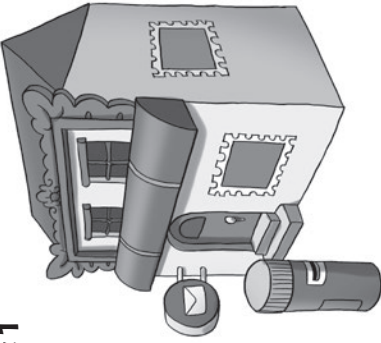

Unit 1

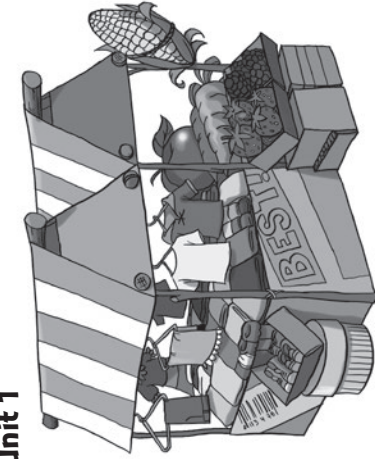

Unit 1

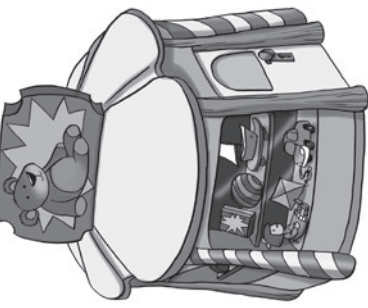

Unit 2

11

Unit 2

12

Unit 2

13

Unit 2

14

Unit 2

15

Unit 2

17

Unit 2

18

Unit 2

19

Unit 2

20



Unit 3

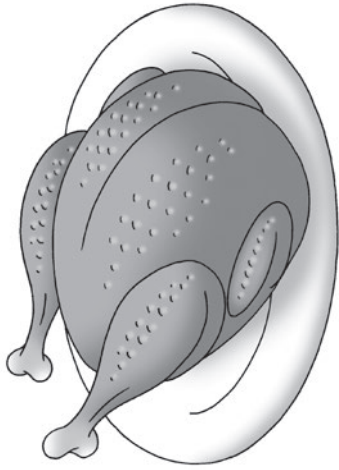

Unit 3

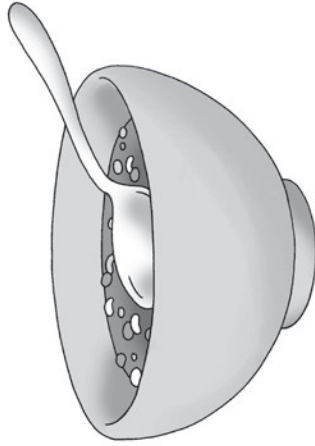

Unit 3

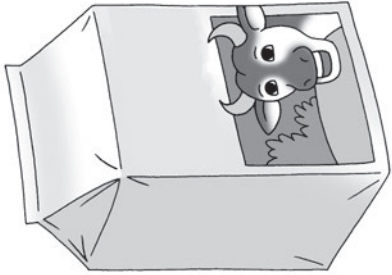

Unit 3

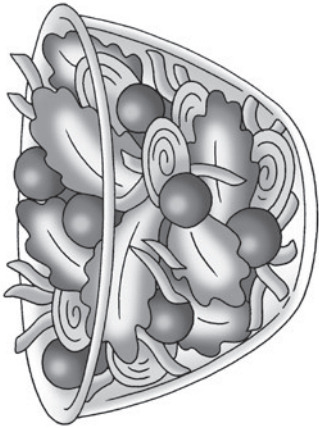

Unit 3



Unit 3

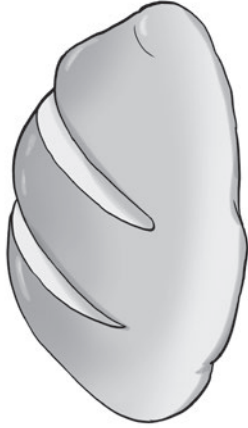

Unit 3

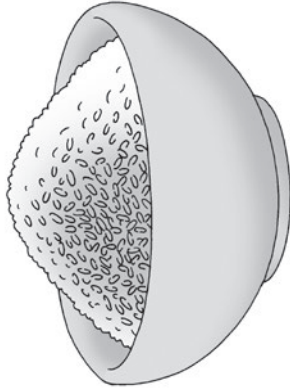

Unit 3



Unit 4

10

Unit 4

30

Unit 4

40

Unit 4

50

Unit 4

60

Unit 4

70

Unit 4

80

Unit 4

90

Unit 4

100

Unit 4

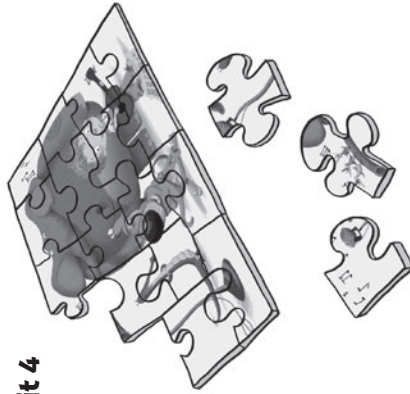

Unit 4



Unit 4

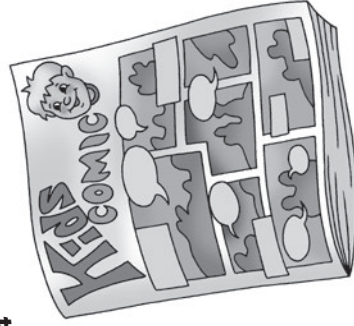

Unit 4

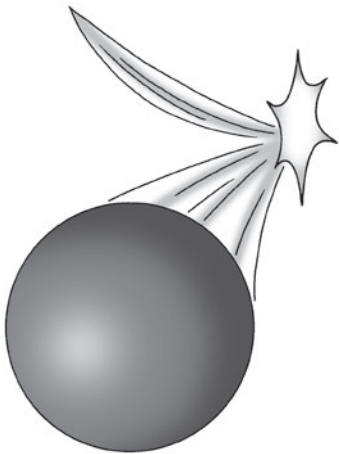

Unit 4

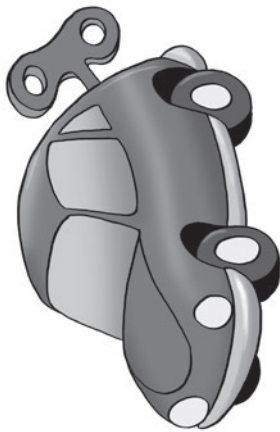

Unit 4

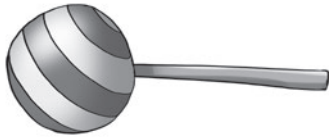

Unit 4

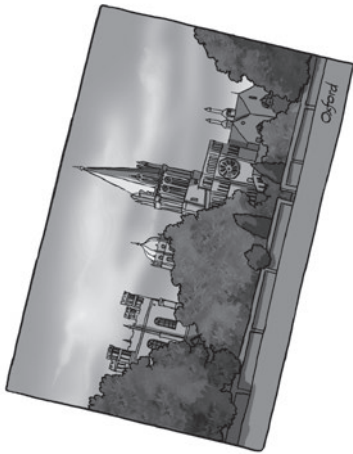

Unit 5

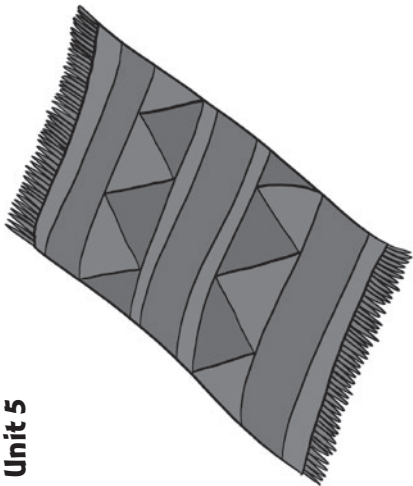

Unit 5

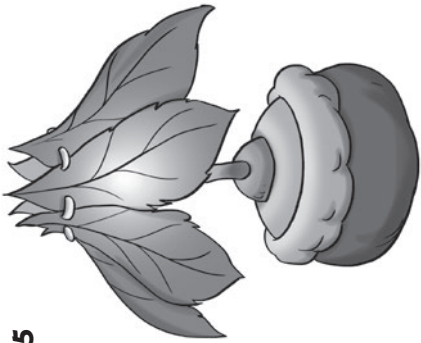

Unit 5

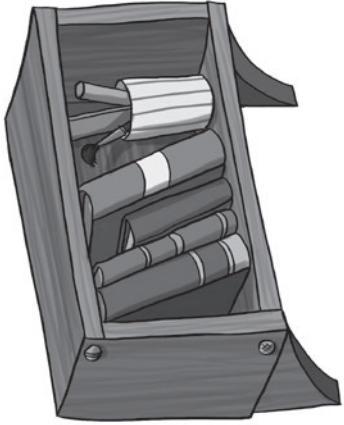

Unit 5

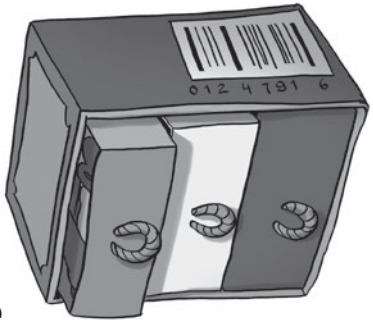

Unit 5

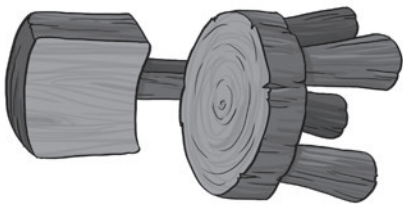

Unit 5

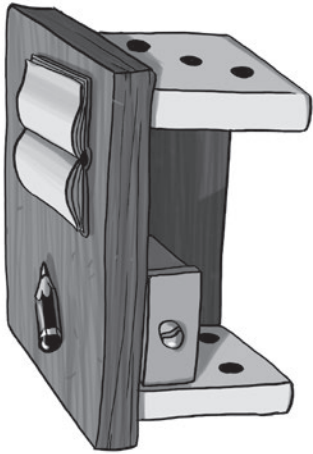

Unit 5

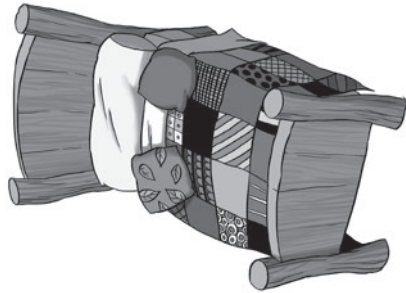

Unit 5

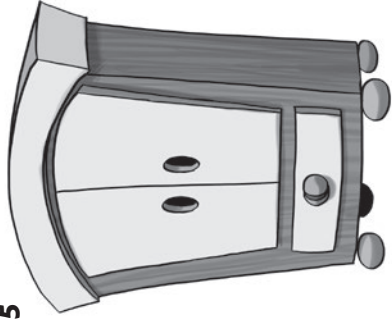

Unit 6

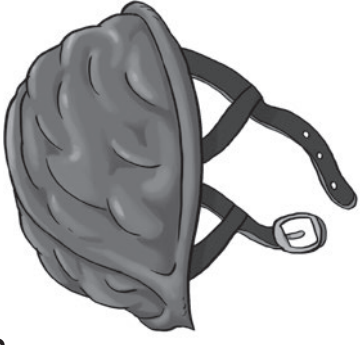

Unit 6



Unit 6

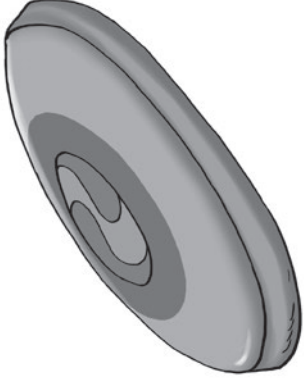

Unit 6

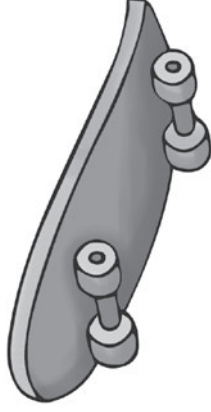

Unit 6



Unit 6



Unit 6



Unit 6



Unit 7

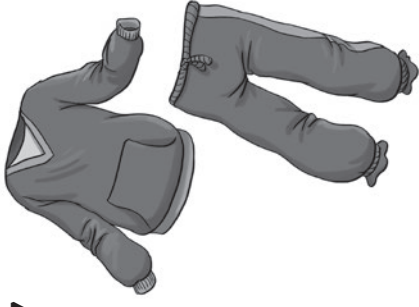

Unit 7

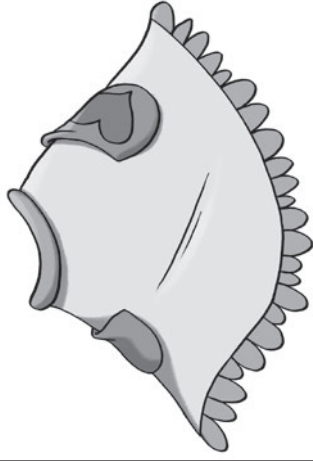

Unit 7



Unit 7



Unit 7



Unit 7

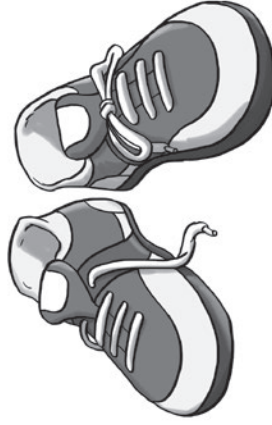

Unit 7

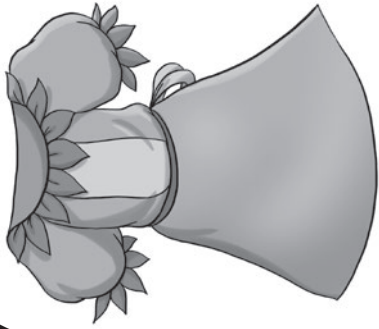

Unit 7





Unit 8



Unit 8



Unit 8



Unit 8

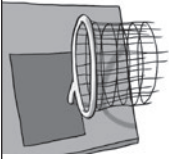

Unit 8



Unit 8



Unit 8



Unit 8

